



TEST REPORT

FILK

a Subsidiary of KFPA

Report No : GK2024-0066E

Page(1)/(8)Pages



1030, Gyeongchung-daero, Ganam-eup, Yeosu-si, Gyeonggi-do, 12661, Korea

1. Client

- Name : Lee, Suckwoo, Saint-Gobain Isover Korea Co., Ltd
- Address : #1, 70, Bugokgongdan 1-gil, Songak-eup, Dangjin-si, Chungcheongnam-do, Korea
- Date of Receipt : 2025. 2. 4.

 2. Test specimen : Glasswool Insulation Board 64 kg/m³ 50 mm

3. Date of Test : 2025. 2. 4.

4. Use of Report : Capability Verification

 5. Location of Test : Permanent Testing Lab On Site Testing

(Address : 1030, Gyeongchung-daero, Ganam-eup, Yeosu-si, Gyeonggi-do, 12661, Korea)

6. Test method : KS F 2805 : 2014

7 Test Environment : Temperature : (17 ± 1) °C, Humidity : (50 ± 5) % R.H.

8 Test Results

Test	Results				Reference
	Frequency (Hz)	Sound absorption coefficient(a_s)	Frequency (Hz)	Sound absorption coefficient(a_s)	
Sound absorption coefficient	100	0.12	800	1.20	Details : Refer to the Contents
	125	0.20	1 000	1.16	
	160	0.37	1 250	1.21	
	200	0.57	1 600	1.11	
	250	0.82	2 000	1.11	
	315	1.00	2 500	1.08	
	400	1.13	3 150	1.11	
	500	1.18	4 000	1.11	
630	1.17	5 000	1.13		

* The results shown in this test report refer only to the specimen(s) tested unless otherwise stated.

Affirmation	Tested by	Technical Manager
	Name : Jeong Jeongho (Signature)	Name : Kim Junguk (Signature)



Fire Insurers Laboratories of Korea

a subsidiary of Korean Fire Protection Association

Accredited by KOLAS, Republic of KOREA

The above test report is the accredited test result by Korea Laboratory Accreditation Scheme, which signed the ILAC-MRA.



	FILK a Subsidiary of KFPA	Report No : GK2024-0066E Page(2)/(8)Pages		
---	-------------------------------------	--	---	---

1. SUMMARY

The purpose of the test was to determine the sound absorption coefficient and noise reduction coefficient(NRC) of the specimen through the acoustic test in accordance with KS F 2805:2014 (Measurement of sound absorption in a reverberation room).

2. CONSTRUCTION OF THE TEST SPECIMEN

The test specimen supplied and constructed by Saint-Gobain Isover Korea Co., Ltd as shown in **Table 1**. (See Appendix 1, 2.)

2.1 Test specimen : Glasswool Insulation Board 64 kg/m³ 50 mm

2.2 Test specimen size : Width 3 000 mm × Length 4 000 mm × Thickness 50 mm (Area : 12 m²)

〈Table 1〉 Material components and arrange of the specimens

(Dimension : mm)

Material components	
Specimen unit size	Width 1 000 × Length 2 000 × Thickness 50
Installation of specimen	Glasswool Insulation Board 64 kg/m ³ 50

2.3 The details of the specimen was shown in appendix 1.

3. TEST PROCEDURE

3.1 Measuring Position and Repeat



The reverberation time of the room with and without the specimen were measured 20 times at 5 microphone points in reverberation room.

The microphone positions were located in the reverberation room with distance of not less than 2m from sound source and 1.5m from other measuring positions, and the distance between the specimen and wall boundary was 1 m at least.



D08-09C(3)

210×297(mm)

	FILK a Subsidiary of KFPA	Report No : GK2024-0066E Page(3)/(8)Pages		
---	-------------------------------------	--	---	---

3.2 Equivalent Sound Absorption Area of The Empty Reverberation Room (A_1)

The equivalent sound absorption area of the empty reverberation room, $A_1(\text{m}^2)$ were calculated by equation (1) as follows

$$A_1 = \frac{55.3 V}{c T_1} - 4 V m_1 \quad \text{----- (1)}$$

where V : Volume of the empty reverberation room(m^3)
 c : Propagation speed of sound in air($c = 331 + 0.6 t/^\circ\text{C}$, m/s)
 T_1 : Reverberation time of the empty reverberation room(s)
 m_1 : Power attenuation coefficient in the empty reverberation room(m^{-1})
($m = \alpha/10\log(e)$, α : sound absorption coefficient in the atmospheric pressure)

3.3 Equivalent Sound Absorption Area of The Reverberation Room with The Test Specimen (A_2)

The equivalent sound absorption area of the reverberation room with the test specimen, $A_2(\text{m}^2)$ were calculated by equation (2) as follows

$$A_2 = \frac{55.3 V}{c T_2} - 4 V m_2 \quad \text{----- (2)}$$

where T_2 : Reverberation time of the empty reverberation room(s)
 m_2 : Power attenuation coefficient in the reverberation room with the test specimen(m^{-1})
($m = \alpha/10\log(e)$, α : sound absorption coefficient in the atmospheric pressure)



3.4 Equivalent Sound Absorption Area of The Test Specimen (A_T)

The equivalent sound absorption area of the test specimen, $A_T(\text{m}^2)$ were calculated by equation (3) as follows

$$A_T = A_2 - A_1 = 55.3 V \left(\frac{1}{c_2 T_2} - \frac{1}{c_1 T_1} \right) - 4 V (m_2 - m_1) \quad \text{----- (3)}$$

where c_1 : Propagation speed of sound in air at the temperature $t_1(\text{m/s})$
 c_2 : Propagation speed of sound in air at the temperature $t_2(\text{m/s})$



	FILK a Subsidiary of KFPA	Report No : GK2024-0066E Page(4)/(8)Pages		
---	-------------------------------------	--	---	---

3.5 Sound absorption coefficient (α_s)

The sound absorption coefficient, α_s , of a plane absorber or a specified array of test objects were calculated by equation (4) as follows

$$\alpha_s = \frac{A_T}{S} \quad \text{-----} \quad (4)$$

where A_T : Equivalent sound absorption area of the test specimen(m^2)

S : Area covered by the test specimen(m^2)

3.6 Frequency Range of Measurements

From 100 Hz to 5 000 Hz (Defined as one-third octave band)

4. TEST FACILITY

4.1 Test Room

The structure of the test room is made of reinforced concrete in thickness of 300 mm.

The shape of the reverberation room is irregular polyhedrons and the volume is 200 m^3 with seven faces.

4.2 Test Instrument

4.2.1 Sound Source

- Broad band noise with amplifier and loudspeaker
- Instrument model : B&K 4296 made in Denmark

4.2.2 Microphone

- Omni-directional microphone
- Instrument model : B&K 4942 made in Denmark

4.2.3 Sound Level Analyser

- Real-time frequency analyser
- Instrument model : B&K PULSE made in Denmark



D08-09C(3)

210×297(mm)

 FILK a Subsidiary of KFPA	Report No : GK2024-0066E Page(5)/(8)Pages	 
---	--	---

5. TEST RESULTS

As the results of the tests, the sound absorption coefficient(α_s) and NRC of each specimen was evaluated as shown in **table 2**.

〈Table 2〉 TEST RESULTS

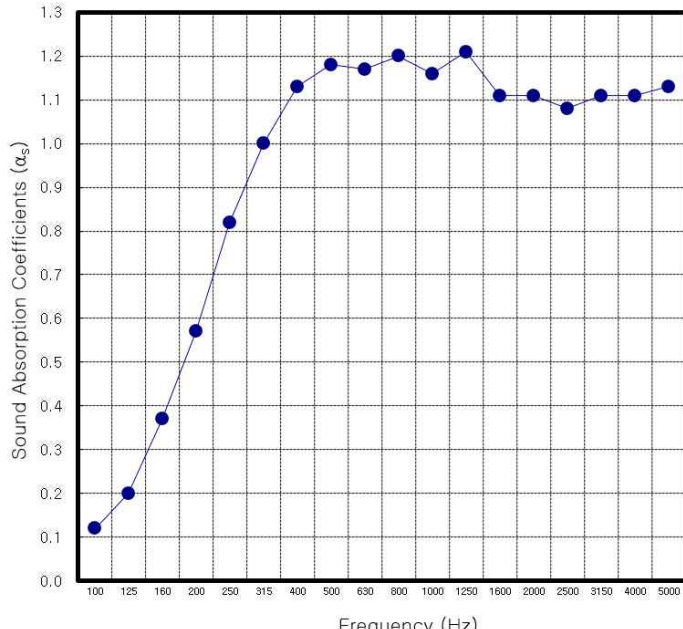
Test method	KS F 2805 : 2014		Date of Test	2025. 2. 4.
Test specimen	Glasswool Insulation Board 64 kg/m ³ 50 mm		Condition	Temperature : (17 ± 1) °C Humidity : (50 ± 5) % R.H
Frequency (Hz)	Reverberation time (s)		Sound absorption coefficient(α_s)	※ MEASURED GRAPH 
	(T_1)	(T_2)		
100	19.57	10.30	0.12	
125	17.01	7.49	0.20	
160	14.92	4.90	0.37	
200	14.62	3.56	0.57	
250	13.04	2.62	0.82	
315	12.44	2.21	1.00	
400	10.88	1.96	1.13	
500	9.97	1.87	1.18	
630	8.62	1.81	1.17	
800	8.07	1.76	1.20	
1 000	7.32	1.77	1.16	
1 250	6.77	1.68	1.21	
1 600	6.42	1.76	1.11	
2 000	5.67	1.70	1.11	
2 500	4.75	1.64	1.08	
3 150	3.78	1.48	1.11	
4 000	3.01	1.34	1.11	
5 000	2.31	1.18	1.13	
NRC	1.07			

○ Specimen unit size :



Width 1 000 mm × Length 2 000 mm × Thickness 50 mm

○ Installation of specimen : Glasswool Insulation Board 64 kg/m³ 50 mm

D08-09C(3)

210×297(mm)



 <p>FILK a Subsidiary of KFPA</p>	<p>Report No : GK2024-0066E Page(6)/(8)Pages</p>		
---	--	---	---

APPENDIX 1.

DRAWING OF THE TEST SPECIMEN

(Dimension : mm)

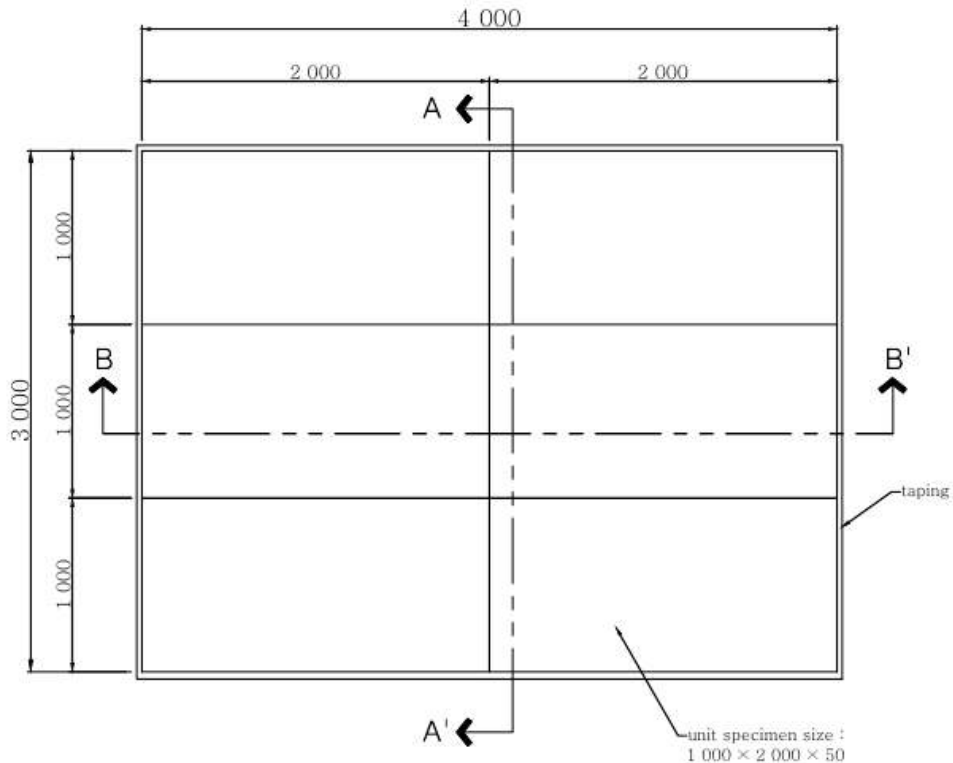

P L A N

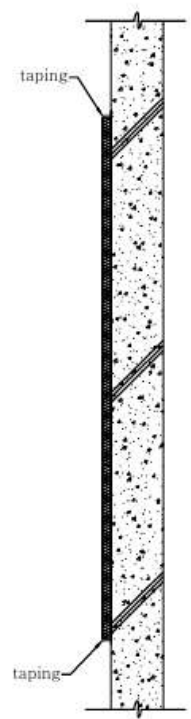

A-A' SECTION

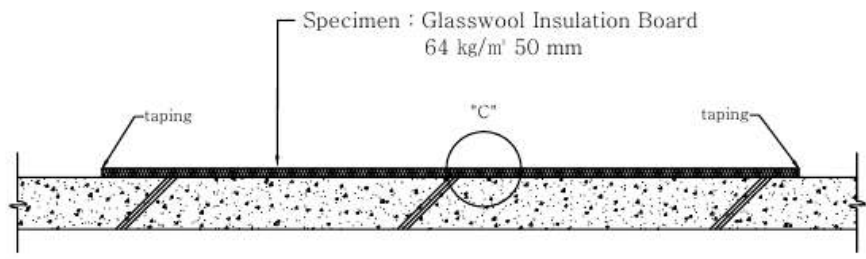

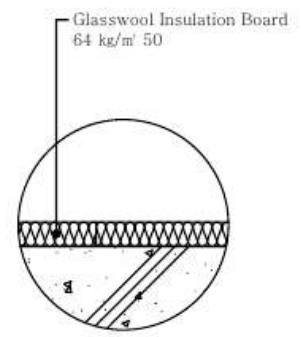

B-B' SECTION



"C" Detail



 <p>FILK a Subsidiary of KFPA</p>	<p>Report No : GK2024-0066E Page(7)/(8)Pages</p>		
---	--	---	---

APPENDIX 2.

PHOTOGRAPHS

[PHOTO 1] Test specimen arranged in reverberation room





[PHOTO 2] Details of the test specimen arrangement



D08-09C(3)

210×297(mm)

	FILK a Subsidiary of KFPA	Report No : GK2024-0066E Page(8)/(8)Pages		
---	-------------------------------------	--	---	---

APPENDIX 3.

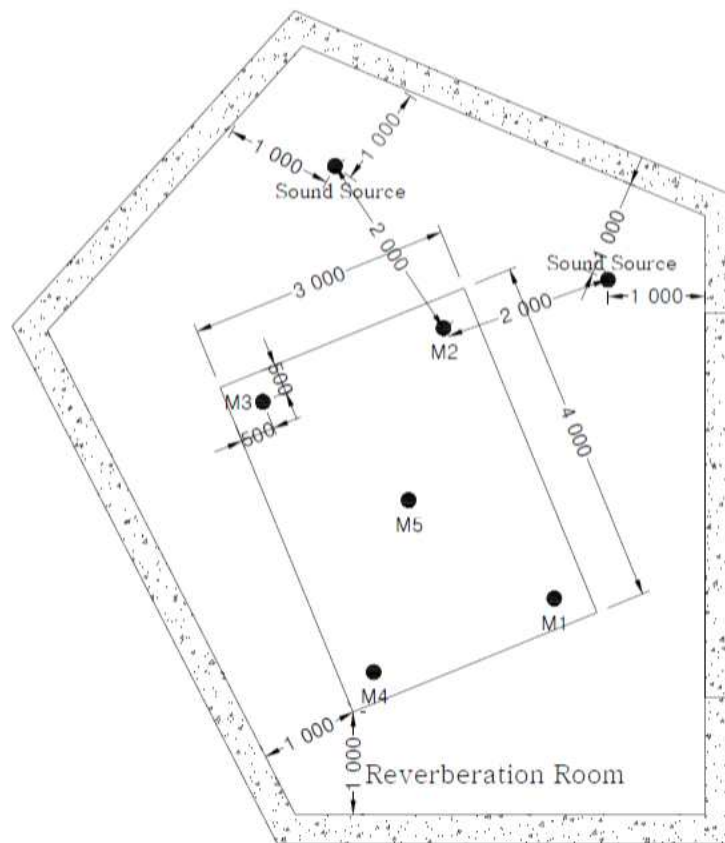
LAYOUT OF THE TEST FACILITY

* M1, M2, M3, M4, M5 : Microphone position (Measuring point)

* Height of each receiving point of microphone position is 1.5 m.



D08-09C(3)

210×297(mm)